

TOK-L · OKRE-L TOK-FP · OKRE-FP CLE

SERIES



TOK Series



OKRe Series

Flat head slotted screw setting control

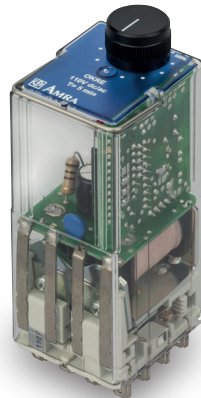

OKRe Series

Knob setting control

LOGIC RELAYS:

FLASHERS ONE-SHOT

APPLICATIONS



Shipbuilding



Petroleum industry



Heavy industry



Power generation



Power distribution



Rolling stock

OVERVIEW

- “L”: flasher function with symmetrical output pulse, adjustable or fixed
- “FP”: one-shot function adjustable
- Wide range of time settings available
- Solid and rugged construction for heavy or intensive duty
- Considerable long-life
- Patent operating mechanism, designed to ensure high contact pressure (TOK)
- Independent and self-cleaning contacts
- Magnetic arc blow-out standard
- Excellent shock and vibration resistance
- Wide range of sockets
- Retaining clip for secure locking of relay on socket
- Transparent cover, pull-out handle
- Positive mechanical keying for relay and socket

DESCRIPTION

Logic relays of “FLASHER” or “ONE SHOT” type are available in 5 models, derived from the TOK and OKR series.

TOK-L, OKRe-L and CLE models are flasher type relays, whereas TOK-FP and OKRe-FP models are of the one-shot type. Relays of the TOK series provide higher breaking capacity and longer mechanical life expectancy than those of the OKR / CLE series.

Flasher relays: when the component is energized, the coil of the relay is piloted by an electronic circuit, delivering voltage pulses in a continuous symmetrical ON/OFF cycle. Accordingly, the contacts change status cyclically, for as long as the control voltage is applied to the circuit. These relays can be specified with an adjustable or fixed intermittence frequency; in the case of an adjustable frequency, the setting is made by way of a potentiometer having a knob type or flat head slotted screw type control.

One-shot relay: when the component is energized, the coil of the relay is piloted by an electronic circuit, delivering voltage pulses. Accordingly, the contacts change status instantaneously and return to the break conditions after a predetermined interval of time, even with the control voltage applied to the circuit.

Relays can be provided with a pulse of adjustable duration or a pulse of fixed duration. In the case of an adjustable pulse, the setting is made by way of a potentiometer having a knob type or a flat head slotted screw type control.

Excellent electrical and mechanical performance levels allow the product to be used in the most demanding of sectors such as, for example, in electricity generating stations, electrical transformer stations, rail transport or in industries using continuous production processes (chemical and petrochemical, rolling mills, cement factories, etc.). In particular, with their notable shock and vibration resistance, they are ideal for use on rolling stock.

STANDARD COMPLIANCE

EN 61810-1	EN 60077
EN 61810-2	EN 50155
EN 61810-7	EN 60695-2-10
EN 61812-1	EN 61000
EN 61373	EN 60529
EN 45545-2	ASTM E162, E662



MODELS	LOGIC FUNCTION	NUMBER OF CONTACTS	RANGE OF CONTACTS	OUTPUT	SETTING CONTROL		ROLLING STOCK APPLICATION
					KNOB	FLAT HEAD SLOTTED SCREW	
OKRe-L	Flasher	4	5A	50% ON / 50% OFF adjustable up to 1h	•	•	•
TOK-L		4	10A	50% ON / 50% OFF adjustable up to 1h		•	•
CLE		4	5A	50% ON / 50% OFF fixed 55-90 pulse/min	-	-	
OKRe-FP	One-shot	4	5A	Adjustable up to 1h	•	•	•
TOK-FP		4	10A	Adjustable up to 1h		•	•



FOR PRODUCT CODE CONFIGURATION, SEE THE "ORDERING SCHEME" TABLE



COIL DATA	
Nominal voltages at Un ⁽¹⁾	DC: 24 - 36 - 48 - 72 - 110 - 125 - 132 - 144 - 220 - AC: 24 - 48 - 110 - 125 - 220 - 230
Max Consumption at Un (DC/AC)	4 W / 4 VA
Operating range ⁽¹⁾	80...115% Un DC: 70...125% Un
Rolling stock version ⁽²⁾	
Type of duty	Continuous

(1) Other values on request.

(2) See "Ordering scheme" table for order code.



CONTACT DATA		CLE - OKRe-L - OKRe-FP	TOK-L - TOK-FP
Number and type		4 SPDT, form C	
Current	Nominal ⁽¹⁾	5 A	10 A
	Maximum peak (1 s) ⁽²⁾	10 A	20 A
	Maximum pulse (10 ms) ⁽²⁾	100 A	150 A
Example of electrical life expectancy ⁽³⁾		0.2 A – 110 Vdc – L/R = 0 ms : 10 ⁵ operations 1,800 operations / h	0.5 A – 110 Vdc – L/R = 40 ms : 10 ⁵ operations 1,800 operations / h
Minimum load ⁽⁴⁾	Standard contacts	500mW (20V, 20mA)	
	Gold-plated contacts P4GEO ⁽⁵⁾	100mW (10V, 5mA)	200mW (20V, 5mA)
	Gold-plated contacts P8 ⁽⁵⁾	50mW (5V, 5mA)	-
	Maximum breaking voltage	250 Vdc / 350 Vac	350 Vdc / 440 Vac
Contact material		AgCu	

(1) Nominal current: on all contacts simultaneously, reduction of 30%.

(2) The max. peak and pulse currents are those currents that can be handled, for a specified time, by the contact. They do not refer to steady or interrupted currents.

(3) For other values, see electrical life expectancy curves.

(4) Values referred to a new product, measured in laboratory. The ability to maintain this performance over the time depends on the environmental conditions and the contact' frequency use. The use of gold plated contacts is recommended in the case of very low loads.

(5) Specifications of gold-plated contacts on new relay

a) Plating material: **P4GEO**: gold-nickel alloy (>6µ) **P8**: gold-cobalt alloy (>5µ), knurled contacts.

b) When the gold-plated contact is subject to heavy loads, it will be degraded on the surface. In such case, the characteristics of the standard contact should be taken into consideration. This does not impair relay operation.



INSULATION	CLE - OKRe-L - OKRe-FP	TOK-L - TOK-FP
Insulation resistance (at 500Vdc) between electrically independent circuits and between these circuits and ground between open contact parts	> 1,000 MΩ > 1,000 MΩ	
Withstand voltage at industrial frequency between electrically independent circuits and between these circuits and ground between open contact parts	2 kV (1 min.) - 2.2kV (1 s) 1 kV (1 min.) - 1.1kV (1 s)	2 kV (1 min.) - 2.2kV (1 s) 2 kV (1 min.) - 2.1kV (1 s)
Impulse withstand voltage (1.2/50µs - 0.5J) between electrically independent circuits and between these circuits and ground between open contact parts	5 kV 3 kV	5 kV 5 kV

MECHANICAL SPECIFICATIONS	CLE - OKRe-L - OKRe-FP	TOK-L - TOK-FP
Mechanical life expectancy	20x10 ⁶ operations	100x10 ⁶ operations
Degree of protection (with relay mounted)	IP40	
Dimensions (mm) ⁽¹⁾	40x45x97	45x45x109
Weight (g)	~ 220	~ 300

(1) Excluding output terminals and adjuster knob, if specified.

ENVIRONMENTAL SPECIFICATIONS	CLE - OKRe-L - OKRe-FP	TOK-L - TOK-FP
Operating temperature	-25 ÷ +55°C	
Rolling stock version	-25 ÷ +70°C	
Storage and shipping temperature	-25 ÷ +85°C	
Relative humidity	Standard: 75% RH - Tropicalized: 95% RH	
Resistance to vibrations	5g - 10 to 55 Hz - 1 min.	5g - 5 to 60 Hz - 1 min.
Resistance to shock	20g - 11ms	30g - 11ms
Fire behaviour	V0	

STANDARDS AND REFERENCE VALUES	
EN 61810-1, EN 61810-2, EN 61810-7	Electromechanical elementary relays
EN 61812-1	Timer relays
EN 60695-2-10	Fire behaviour
EN 61000	Electromagnetic compatibility
EN 60529	Degree of protection provided by enclosures

Unless otherwise specified, the products are designed and manufactured according to the requirements of the above-mentioned European and International standards.

In accordance with EN 61810-1, all technical data are referred to ambient temperature of 23°C, atmospheric pressure of 96kPa and 50% humidity.

Tolerance for coil resistance and nominal power is ±7%.

RAILWAYS, ROLLING STOCK – STANDARDS	
EN 60077	Electric equipment for rolling stock - General service conditions and general rules
EN 50155	Electronic equipment used on rolling stock
EN 61373	Shock and vibration tests, Cat 1, Class B
EN 45545-2	Fire behaviour, Cat E10, Requirement R26, V0
ASTM E162, E662	Fire behaviour

CONFIGURATIONS – OPTIONS	
P2	Tropicalization of the coil with epoxy resin for use with 95% RH (@ T 50 °C). This treatment also protects the coil against corrosion which could occur by the combination of humidity with certain chemical agents, such as those found in acid atmospheres (typical of geothermal power stations) or saline atmospheres.
P4GEO	Gold plating of contacts with gold-nickel alloy, thickness ≥ 6µ. This treatment ensures long-term capacity of the contact to conduct lower currents in harsh ambient conditions such as acid atmospheres (typical of geothermal power stations) or saline atmospheres.
P5GEO	P4GEO type gold-plating, but applied to contacts, contact terminals and output terminals + P2 coil tropicalization.
P6GEO	Gold-plating of contacts, contact terminals and output terminals + P2 coil tropicalization.
P7	Silver cadmium oxide contacts.
P8	Gold plating of contacts with gold-cobalt alloy, thickness ≥ 5µ, knurled fixed contact. This finish allows further improvement of the gold-plated contact performance compared to the treatment P4GEO .
LED	LED indicator showing presence of power supply, wired in parallel with the coil.
FLYBACK DIODE	Polarized component connected in parallel with the coil designed to suppress overvoltages generated by the coil when de-energized.
TRANSIL	Non-polarized component connected in parallel with the coil. Behaviour is similar to that of a varistor, with faster operating times.

**CLE ORDERING SCHEME**

FUNCTION	PRODUCT CODE	APPLICATION (1)	CONFIGURATION A	CONFIGURATION B	TYPE OF POWER SUPPLY	NOMINAL VOLTAGE (V) (2)	KEYING POSITION (3)
Flasher	CLE	E: Energy F: Railway Fixed Equipment	1: Standard	0: Standard 2: P2 4: P4 GEO 5: P5 GEO 6: P6 GEO 7: P7 8: P8	C: Vdc A: Vac 50 Hz H: Vac 60 Hz	024 - 048 - 110 125 - 230	XXX
Example	CLE	E	1	0	H	125	
	CLEE10-H125: CLE relay, ENERGY series, standard coil, nominal voltage 125Vac 60Hz						

**OKRe-L / OKRe-FP ORDERING SCHEME**

FUNCTION	PRODUCT CODE	APPLICATION (1)	CONFIGURATION A	CONFIGURATION B	TYPE OF POWER SUPPLY	NOMINAL VOLTAGE (V) (2)	SETTING CONTROL (3)	FULL SCALE TIMES (3)	KEYING POSITION (3)
Flasher	OKReL	E: Energy F: Railway Fixed Equipment	1: Standard 2: Diode // 3: Varistor 4: Led 5: Diode // + Led 6: Varistor + Led 7: Transil 8: Transil + Led	0: Standard 2: P2 4: P4 GEO 5: P5 GEO 6: P6 GEO 7: P7 8: P8	T: Vdc+Vac C: Vdc (4)	024 - 036 048 - 072 110 - 125 132 - 144 220 - 230	M = Knob C = Flat head slotted screw	01S: 1 s 05S: 5 s 10S: 10 s 15S: 15 s 30S: 30 s 01M: 1 min 02M: 2 min 05M: 5 min 10M: 10 min 15M: 15 min 30M: 30 min 60M: 60 min	XXX
One-shot	OKReFP	R: Railway Rolling Stock							
Example	OKReL	R	1	2	C	072	M	01S	
	OKReLR12-C072-M01S: OKRe-L relay, rolling stock series, P2 coil tropicalization, nominal voltage 72Vdc, full scale 1 second, knob setting control								
	OKReFP	E	4	8	T	110	C	05M	
OKReFPE48-C110-C05M: OKRe-FP relay, energy series, nominal voltage 110Vdc/ac, full scale 5 minutes, slotted screw setting control, with led, P8 finish (gold-plated contacts)									

**TOK-L / TOK-FP ORDERING SCHEME**

FUNCTION	PRODUCT CODE	APPLICATION (1)	CONFIGURATION A	CONFIGURATION B	TYPE OF POWER SUPPLY	NOMINAL VOLTAGE (V) (2)	FULL SCALE TIMES (3)	KEYING POSITION (3)	
Flasher	TOK-L	E: Energy F: Railway Fixed Equipment	4: Led (fixed range)	0: Standard 2: P2 4: P4 GEO 5: P5 GEO 6: P6 GEO	C: Vdc (4) A: Vac 50 Hz H: Vac 60 Hz	024 - 036 - 048 072 - 110 - 125 132 - 144 - 220 230	01S: 1 s 02S: 2 s 04S: 4 s 08S: 8 s 16S: 16 s 32S: 32 s 01M: 1 min 02M: 2 min 04M: 4 min 08M: 8 min 16M: 16 min 32M: 32 min 64M: 64 min	XXX	
One-shot	TOK-FP	R: Railway Rolling Stock							
Example	TOK-L	R	4	0	C	072	64M		
	TOKLR40-C072-64M: TOK-L relay, railways series, rolling stock, nominal voltage 72Vdc, full scale 64 minutes								
	TOK-FP	E	4	2	A	220	04S		
TOKFPE42-A220-04S: TOK-FP relay, energy series, P2 coil tropicalization, nominal voltage 220Vac, full scale 4 seconds									

(1) ENERGY: all applications except for railway.

RAILWAYS, FIXED EQUIPMENT: application on fixed power systems and electrical railway traction. Construction according to RFI (FS Group) specification no. RFI DPRIM STF IFS TE 143 A, if applicable. For list of RFI approved and conforming products, consult dedicated catalogue "RAILWAY SERIES - RFI APPROVED".

RAILWAYS, ROLLING STOCK: application on board rolling stock (rail-tram-trolley vehicles). Electrical specifications according to EN60077.

CLE: also available in the Stations series, with ENEL approved material meeting LV15/LV16 specifications. Consult the dedicated catalogue for more information.

(2) Other values on request.

(3) Optional value. The positive mechanical keying is applied according to the manufacturer's model.

(4) Rolling Stock version, Vdc only available.

WIRING DIAGRAM

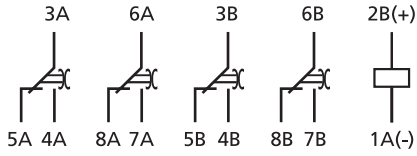

CLE / OKRE-L

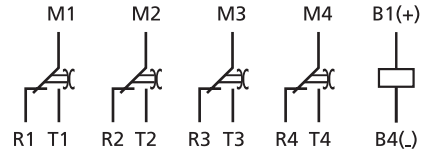

TOK-L

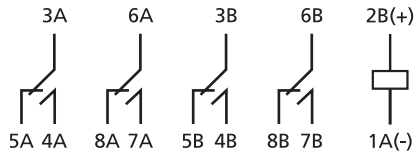

OKRE-FP

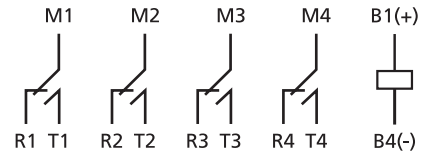

TOK-FP

FUNCTIONAL DIAGRAM

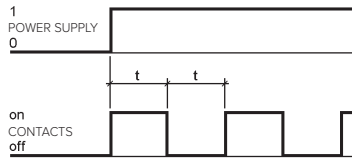

CLE / OKRE-L / TOK-L

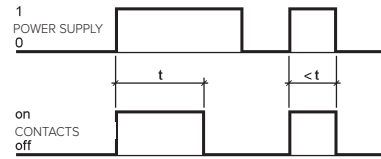

OKRE-FP / TOK-FP

TIME DELAY – SWITCHING TIME SETTING

TIME DELAY – SWITCHING TIME SETTING	OKRE-L - OKRE-FP	TOK-L - TOK-FP	CLE
Time setting	By way of potentiometer, with knob or flat slotted head screw control	By way of potentiometer, with flat slotted head screw control	No time setting 55 ... 90 pulse/min symmetrical
Full scale times available	1-5-10-15-30 seconds, 1-2-5-10-30-60 minutes	1-2-4-8-16-32 seconds, 1-2-4-8-16-32-64 minutes	
Time setting range	10...100 % of full scale	10...100 % of full scale	
Accuracy, setting (0.8...1.1 Un, T=20°C)	±10% of time delay	±5% of time delay	
Accuracy, repeatability	DC: 0.5% / AC: ±0.5% +20ms	DC: 0.5% / AC: ±0.5% +20ms	
Reset	< 100m, in time-delay phase < 1s	< 100m, in time-delay phase < 1s	

DIMENSIONS

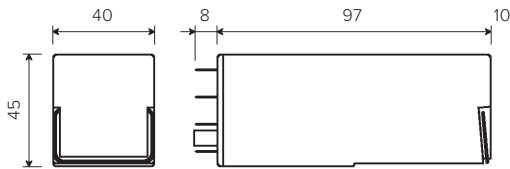

OKRe-L / OKRe-FP
with knob setting control

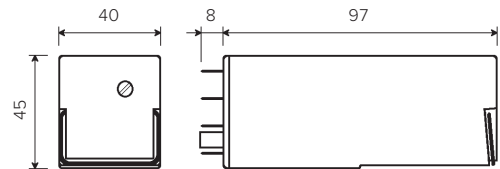

OKRe-L / OKRe-FP
with flat head slotted
screw setting control

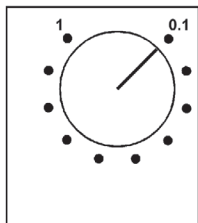

Knob setting control

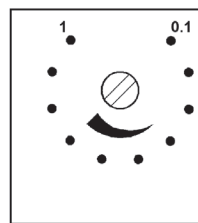

Flat head slotted
screw setting control

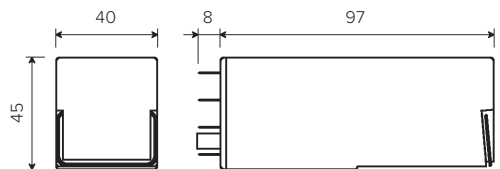

CLE

The scale shown on the relay (0.1-1) is approximate

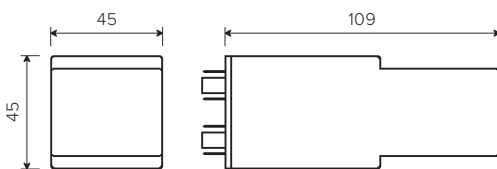

TOK-L / TOK-FP

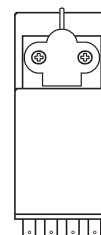

TOK-L / TOK-FP
finish for
ROLLING STOCK version



CLE / OKRE-L / OKRE-FP

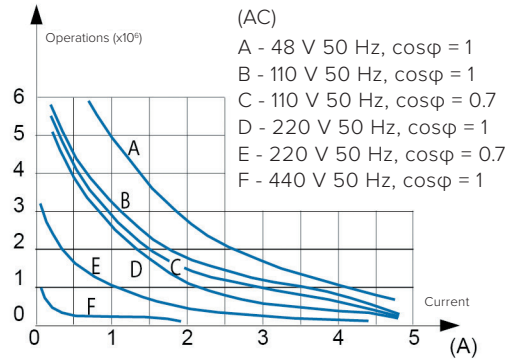
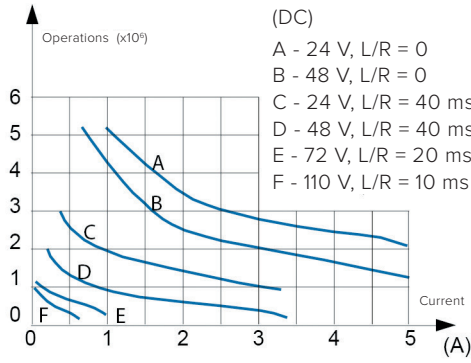

Some examples of electrical life expectancy
 48Vdc - 5 A - L/R = 10 ms : 5 x 10⁵ operations
 80Vdc - 5 A - Resistive: 5 x 10⁵ operations
 110Vdc - 0.5 A - L/R = 10 ms : 5 x 10⁵ operations

220Vdc - 0.2 A - L/R = 10 ms : 10⁵ operations
 110Vac - 5 A - Cosφ = 0.7 : 5 x 10⁵ operations
 220Vac - 3 A - Cosφ = 0.7 : 5 x 10⁵ operations
 440Vac - 0.2 A - Resistive: 5 x 10⁵ operations

TOK-L / TOK-FP

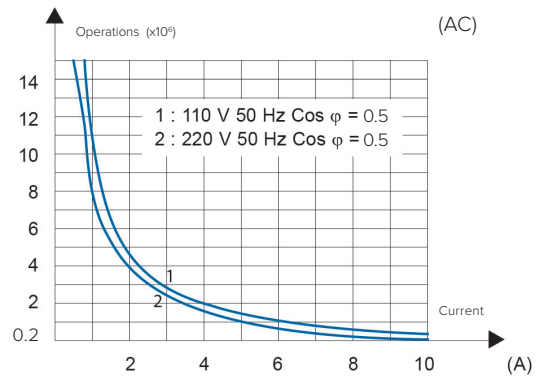
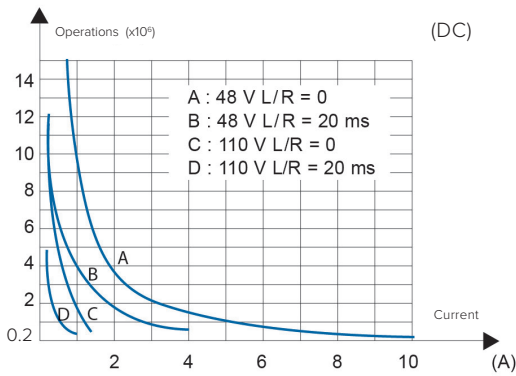

Other examples of electrical life expectancy available on the technical data sheet of the OK series relay (OKSFC model)



SOCKETS AND RETAINING CLIPS

CLE - OKRe-L - OKRe-FP

TOK-L - TOK-FP

Number of terminals (standard dimensions 5 x 0.8 mm)	16	Retaining clip ⁽²⁾	
For wall or rail mounting			
Spring clamp, wall or DIN H35 rail mounting	PAIR160	RC48	RL48
Screw, wall or DIN H35 rail mounting	48BIP20-I DIN	RC48	RL48
Screw, wall mounting	48BL	RC48	RL48
Double faston, wall mounting	48L	RC48	RL48
For flush mounting			
Spring clamp	PRIR160	RC48	RL48
Double faston (4.8 x 0.8 mm)	ADF2	RC48	RL48
Screw	43IL ⁽¹⁾	RC43	RL43
For mounting on PCB			
	65	RC43	RL43

(1) Insert the clip before fastening the socket on the panel.

(2) Assume two clips for use on rolling stock.

For more details, see specifications of mounting accessories.



Installation

Before installing the relay on a wired socket, disconnect the power supply.

The preferential mounting position is on the wall, with the relay positioned horizontally in the "reading orienting" of marking so that the label is readable in the correct sense.

Spacing: the distance between adjacent relays depends on use' conditions.

If a relay is used in the "less favorable" conditions that occur with "simultaneously":

- Power supply: the maximum allowed, permanently
- Ambient temperature: the maximum allowed, permanently
- Current on the contacts: the maximum allowed, permanently
- Number of contacts used: 100%

it is strongly recommended to space relay at least 5 mm horizontally and 20 mm vertically, to allow for proper upward heat' dissipation and increase the longevity of the component.

Actually, relays could be used in less severe conditions. In this case, the distance between adjacent relays can be reduced or abolished. A correct interpretation of the use' conditions allows the optimization of the available spaces. Contact AMRA for more information.

To increase relay' longevity, we recommend mounting relays intended for "continuous use" (permanent power supply), alternating them with relays intended for less frequent use.

For a safe use, the retaining clip is recommended.

For use on rolling stock, relays have been tested to EN 61373 standard equipped with retaining clip(s).

Operation

Before use: if relay is not used, for example after long storage periods, contact resistance may increase due to a natural and slight oxidation or polluting deposits.

In order to restore the optimal conductivity and for standard contacts (NOT gold plated) it is recommended to switch several time a load of at least 110Vdc - 100mA or 24Vdc - 500mA. The contacts will be "cleaned" thanks to the electric arc generated during the current interruption and the mechanical self-cleaning action.

The common contact rubs against the fixed poles (NO and NC contacts) both when opening and when closing, which ensures a self-cleaning action.

An increase in contacts' resistance, in most cases, does not represent a problem. Many factors contribute to the correct use of contact and consequently to the relay' long-term reliability:

- **Load:** the current switching generates an electric arc with cleaning effects. For proper electrical cleaning and performance keeping we recommend:
 - o Standard contacts: Minimum current = 20mA
 - o Gold plated contacts: Minimum current = 10mA
- **Operating frequency:** relays are components that can operate with a wide range of switching frequency. High frequency operation also allows a continuous cleaning effect by "sliding" (mechanical cleaning). In case of low frequency operation (for example few time a day), we advise:
 - o Use of contact with currents twice compared to those indicated.
 - o For currents lower than 10mA, use gold plated contacts and connect 2 contacts in parallel, in order to reduce the equivalent contact resistance
- **Pollution:** the presence of pollution can cause impurities on contact surface. Electric charges attract organic molecules and impurities that are deposited on the contact surface. Electrical and mechanical cleaning, respectively, burn and remove such impurities. In pollution presence, the minimum recommended currents must be respected. In extreme cases, provide double the cleaning current.

Condensation is possible inside the relay when energized and the outside ambient temperature is cold; this is quite normal and does not affect the operation of the relay. Plastic materials of relay do not possess hygroscopic properties.

Maintenance

No maintenance is required.

In case of normal relay wear (reaching the end of electrical or mechanical life), the relay cannot be restored and must be replaced.

To check the component, relay removal must be carried out with slight lateral movements. An "up and down" movement can cause terminals damage.

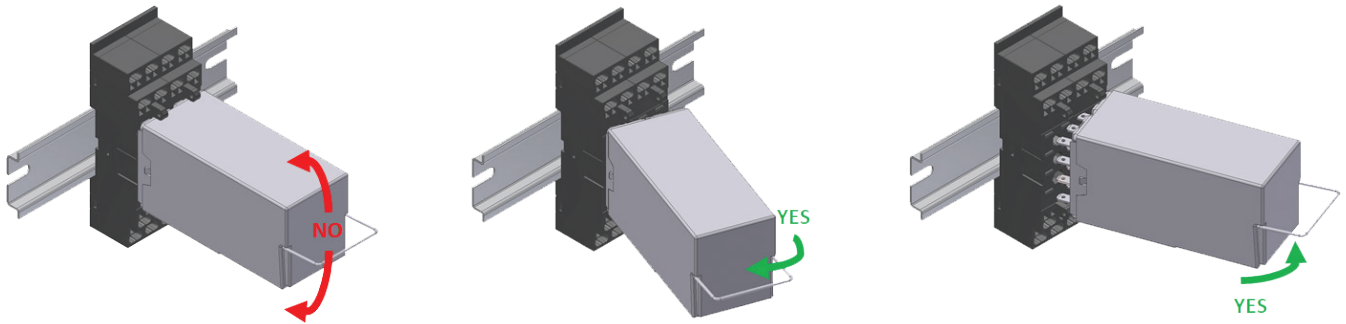

Often the malfunctions are caused by power supply with inverted polarity, by external events or by use with loads exceeding the contact performance.

In case of suspected malfunction, energize relay and observe if mechanical operation of contacts / relay mechanism is performed. Pay attention to the power supply polarity, if relay is equipped with polarized components (example: diode, led).

- In case of expected operation, clean the contacts (see paragraph "OPERATION") and check if the circuit load ranges within the contact performance. If necessary, replace with relays with gold contacts. Note: the electrical continuity of contacts must be checked with adequate current.
- If it does not work, we recommend to use a relay of the same model and configuration.

If an investigation by AMRA is required, pull-out the relay from the socket, don't remove the cap, avoid any other manipulation and contact us. You will be asked for the following data: environmental conditions, power supply, switching frequency, contact load, number of operations performed.

The fault can be described through the "TECHNICAL SUPPORT" section of the website www.amra-chauvin-arnoux.it.

In any case, the relay cannot be repaired by the user.

Storage

Storage conditions must guarantee the environmental conditions (temperature, humidity and pollution) required for the product conservation, in order to avoid deterioration.

The product must be stored in an environment sheltered from atmospheric agents and not polluted, with an ambient temperature between -25 and +85°C with max 75% RH. Humidity can reach peaks of 95%. In any case, there must be no condensation. Before use, please read carefully "OPERATION" section.